

# Signatone S-750 Small, Economic, 3-Axis Micropositioner

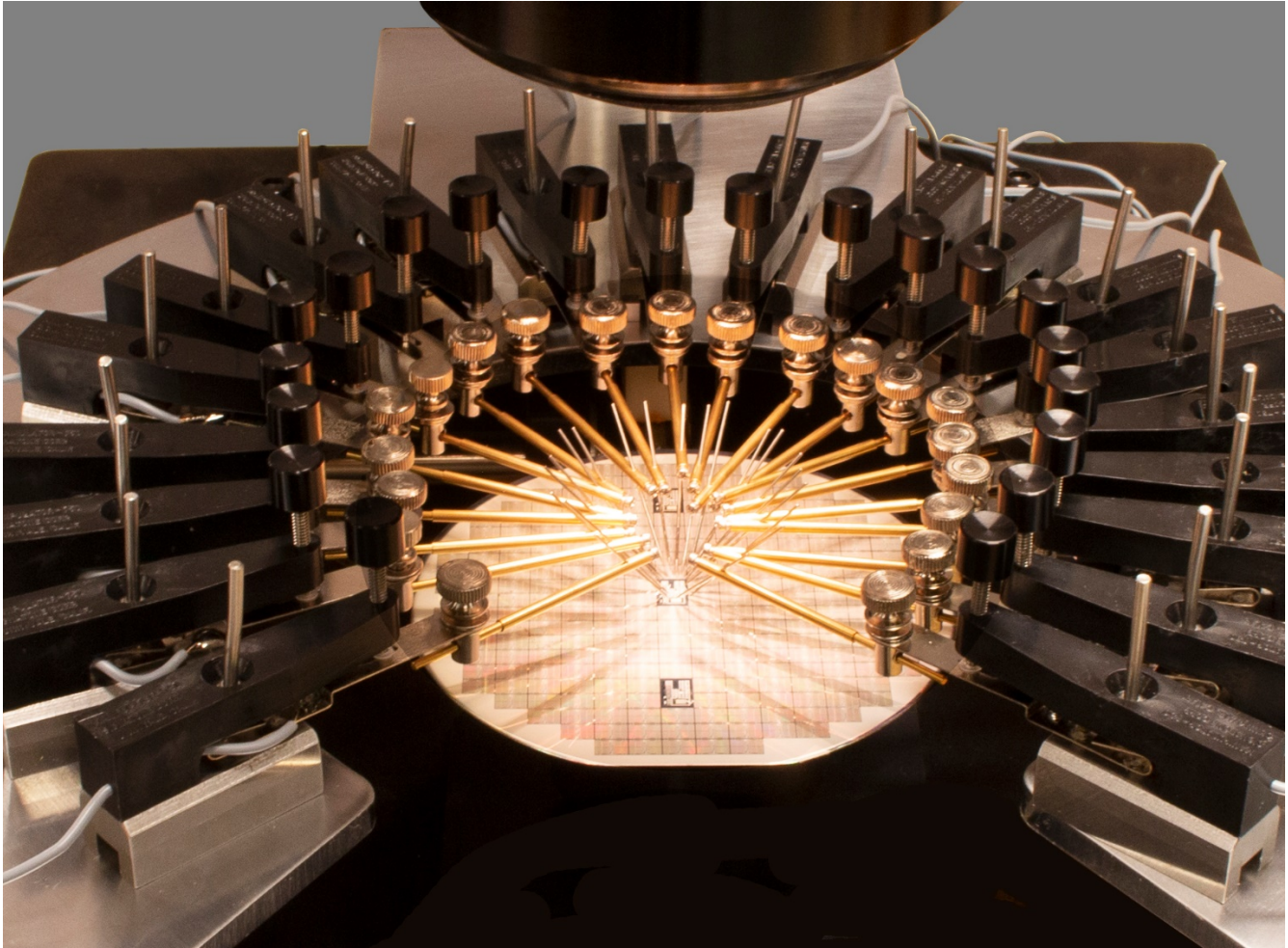

## ❖ FEATURES / APPLICATIONS

Signatone offers an extensive line of Micropositioners to address virtually every probing and measurement application, ranging from the very simple to the highly complex sub-micron high-resolution positioners.

The Model S-750 Micropositioner is designed for probing large area structures (Pads). Its small size and simple design make it easy to place multiple probes down on one device when space is limited. The X-Y scanning area is augmented by the "Z" movement of the probe. The S-750 is considered one of the most economically priced probes in the probing market.

### Designed for a Variety of Probing Applications

- Failure Analysis
- Pad Probing
- RF Biasing
- High Density Probe Placement
- Resistivity Measurements
- MEMS Test
- Your Application

❖ **SPECIFICATIONS**

<b>Model S-750/S-750-1</b>	<b>Joystick Positioner</b>
Travel range	Z = 12.7 mm X-Y = 4.75 mm
Feature resolution	5 μm
"Z" Screw resolution	80 TPI
Mounting	Magnetic
Footprint (W/D)	67mm x 35mm

<b>Application</b>
Small footprint/ allows for multiple probes
RF Biasing
Failure analysis
Pad probing
MEMS Test

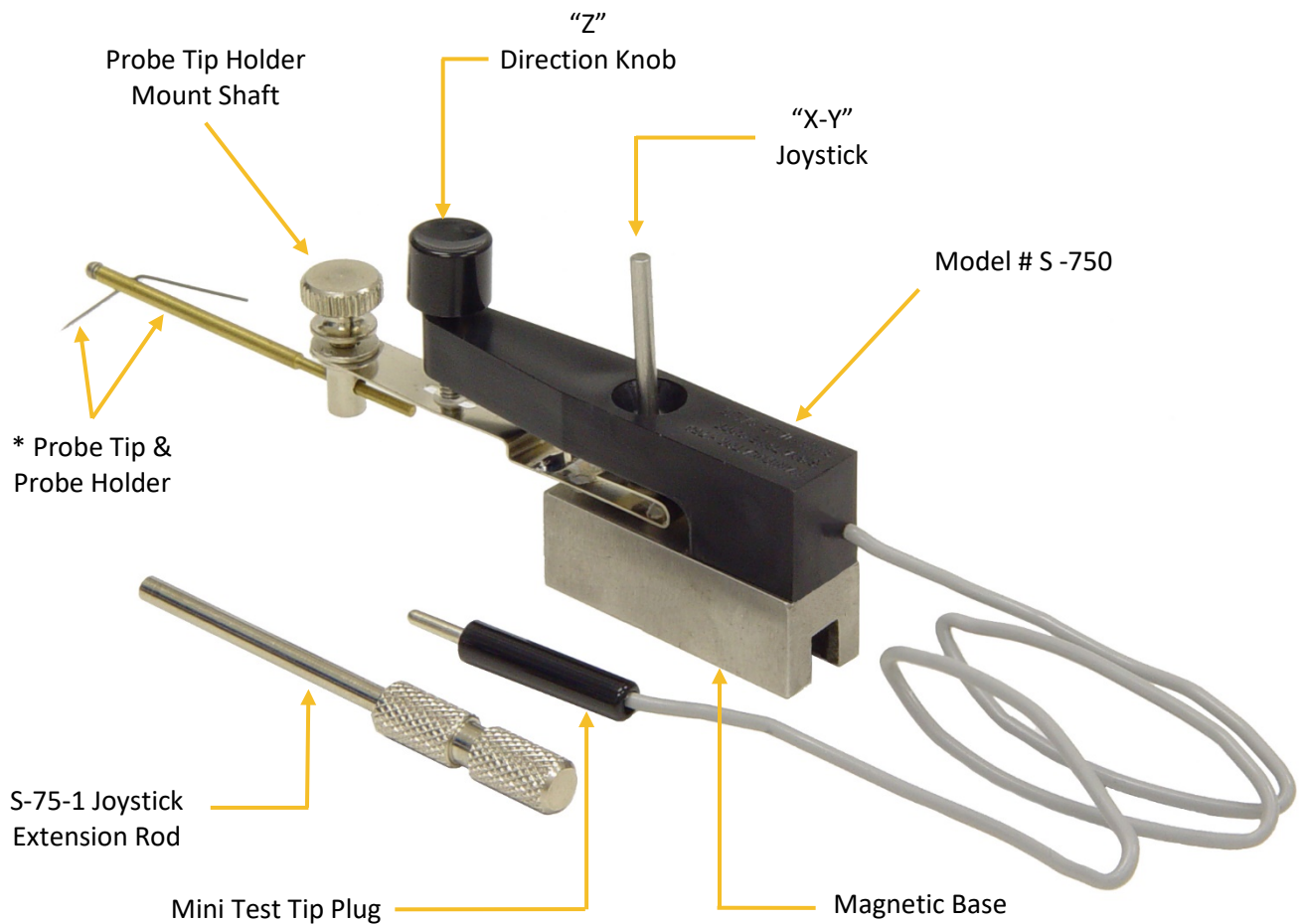
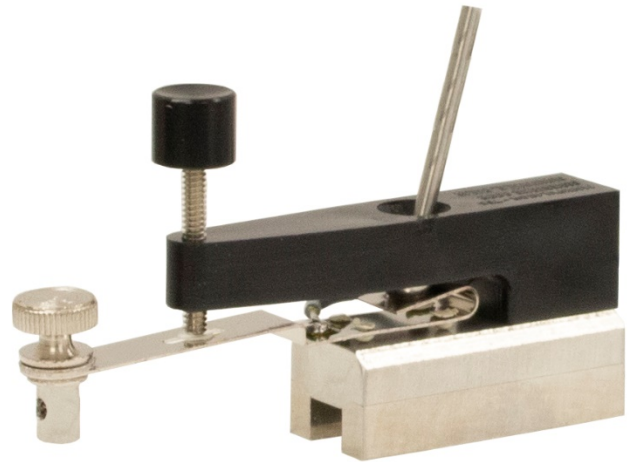

❖ **DIMENSIONS – S-750 and S-751 Economic Joystick Micropositioner**

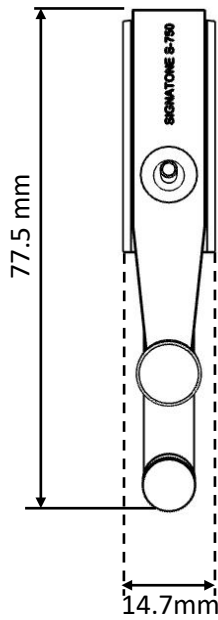

**S-750**

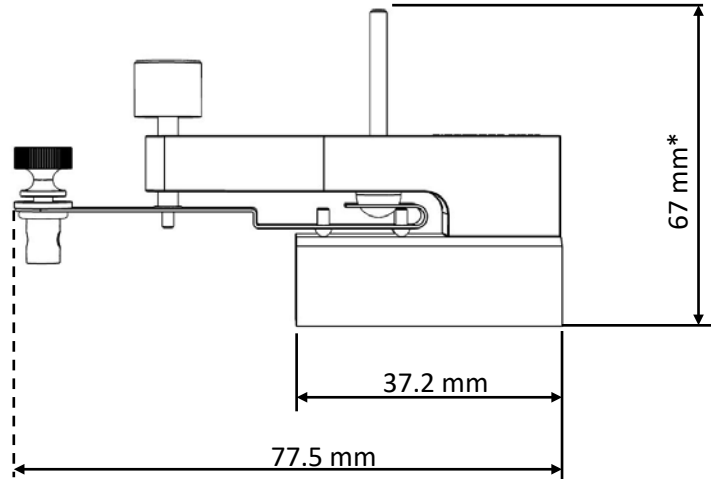

**S-750-1 Extension Rod**

May be added to the S-750  
Micropositioner

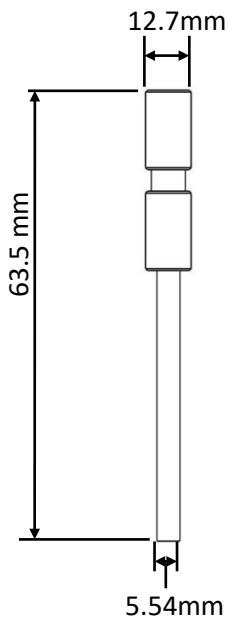

**S-751**

Includes the S-750  
Micropositioner and the  
S-750-1 Extension Rod

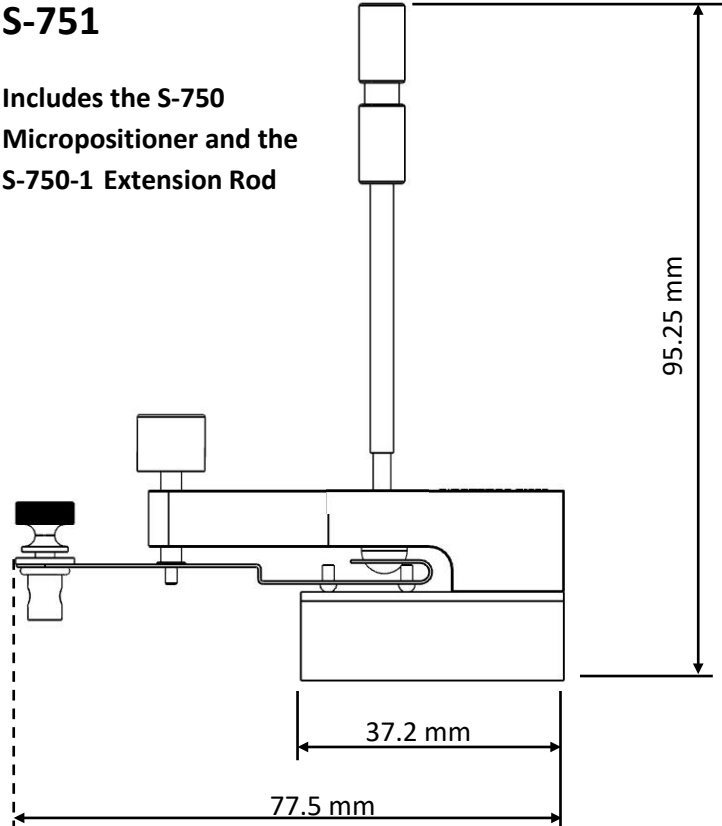

## Signatone Probe Holder Series

Offering a wide variety of probe holders to suit virtually every probing requirement. This Signatone selection guide is for our standard probe holders designed for use with all Signatone Micropositioners. The S1 & S2 length probes are specific for the S-750 model micropositioner.

The Signatone "S" Series probe tip holder comes in three lengths, determined by S1, S2, or S3. The "S" style holder is available in the following Signatone "Length and Tip-Mount" Options

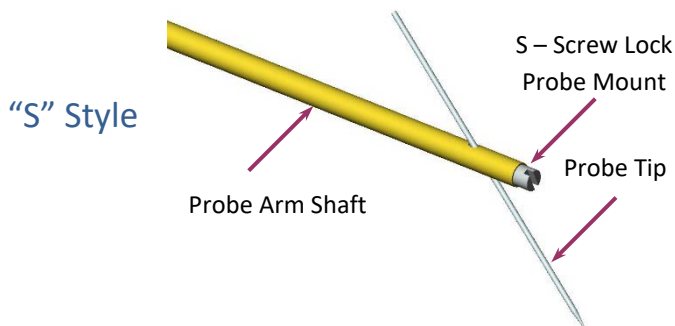
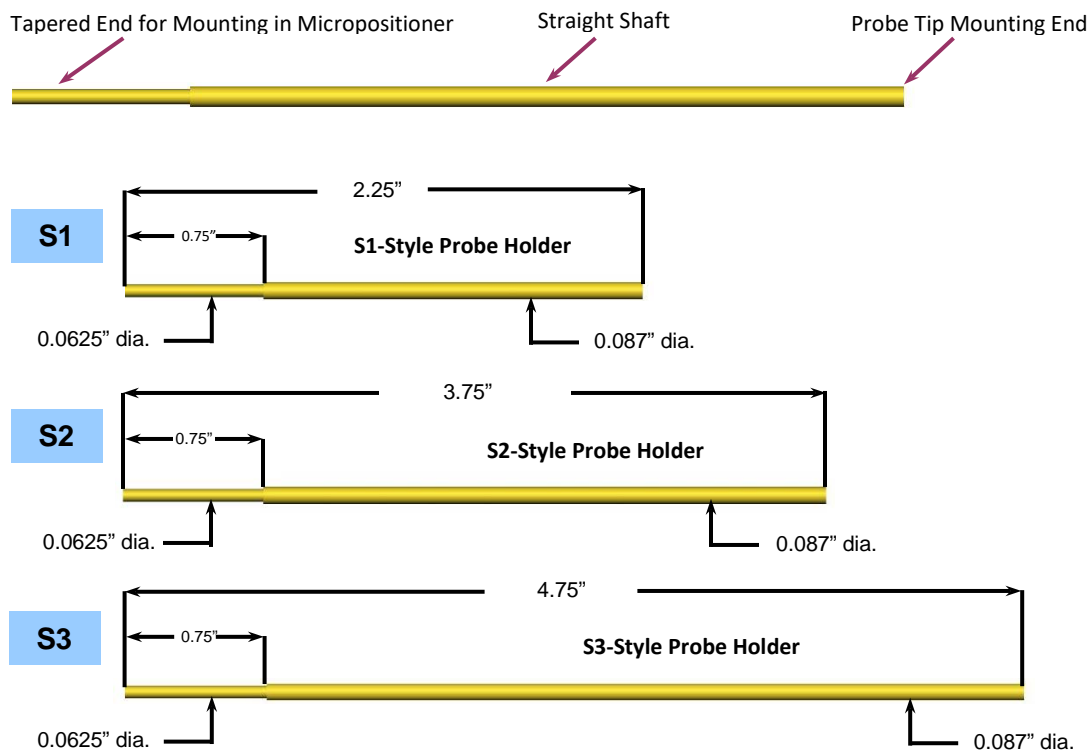

The Signatone "S" or screw locking option probe tip mount secures the probe tip with a set screw allows for easy and quick probe replacement.

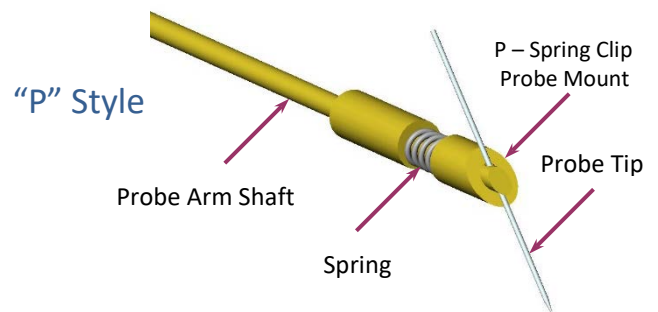

The Signatone "P" or Spring Clip option probe tip mount allows for a quick and easy probe change without the need for any tools.

## Signatone Probe Tips

Offering a wide variety of passive probe tips to suit virtually every probing requirement. This selection guide is our standard offering / special sizes and materials available.

Model Number	Material	TIP Diameter	Shank Diameter	Length
SE-10T	Tungsten	1 µm	0.254mm	31.75mm
SE-10TZ	Tungsten	1 µm	0.254mm	31.75mm
SE-20BC	Beryllium Copper	12 µm	0.51mm	19mm
SE-20BCB	Beryllium Copper	125 µm	0.51mm	19mm
SE-20T	Tungsten	3.5 µm	0.51mm	31.75mm
SE-20TB	Tungsten	20 µm	0.51mm	31.75mm
SE-20TBL	Tungsten	20 µm	0.51mm	50.1mm
SE-20TZ	Tungsten	3.5 µm	0.51mm	31.75mm
SE-O	Osmium	12 µm	0.63mm	19mm
SE-P	Palladium	12 µm	0.63mm	19mm
SE-S	Steel	12 µm	0.63mm	28.45mm
SE-SM	Tungsten	1 µm	0.51mm	50.1mm
SE-SMS	Tungsten	0.2 µm	0.51mm	50.1mm
SE-T	Tungsten	5 µm	0.63mm	31.75mm
SE-TB	Tungsten	25 µm	0.63mm	31.75mm
SE-TC	Tungsten Carbide	12 µm	0.63mm	31.75mm
SE-TG	Gold Plated Tungsten	10 µm	0.51mm	31.75mm
SE-TL	Tungsten	5 µm	0.63mm	50.1mm
SE-TZ	Tungsten	5 µm	0.63mm	31.75mm
SM-10	Tungsten	0.2 µm	0.51mm	30.5mm
SM-35	Tungsten	0.7 µm	0.51mm	30.5mm

Probes with tungsten shank can be cut and bent to a particular shape by the end user.

Z bend models are also available, for more information, contact [sales@signatone.com](mailto:sales@signatone.com)

Packaging: Tips are sold by the box including quantity of 5 tips.

Discounts available on quantity purchases of 20-100 box, +100 boxes.

(contact factory for details)



## Signatone Probe Tips

### There are basically two body styles of probe tips “Hard & Wire”:

The most common style probe tip (referred to as “Hard-TIP”) includes a taper or angle from the probe shaft to the tip. This effect is achieved by etching or a grinding process on the material allowing more mass at the tip end. (recommended for probing through passivation or hard materials)

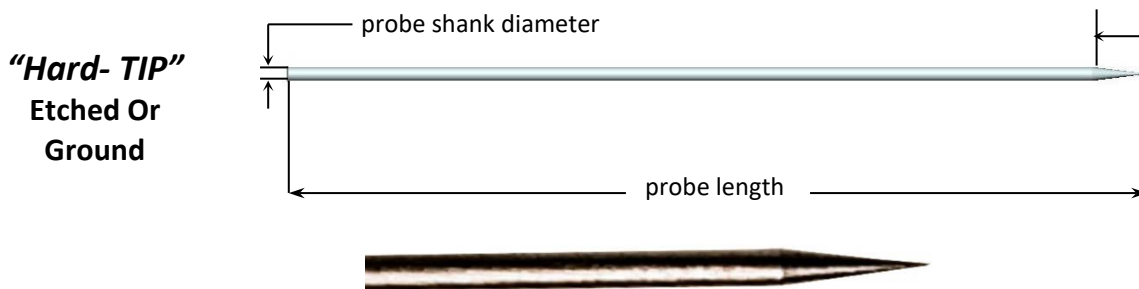

The unique style probe tip (referred to as “Wire or Cat Whisker”) includes straight probe shaft with a fine wire etched to a sub-micron tip and attached to the end. This configuration of probe tip allows for a very fine- sharp and flexible tip while maintaining a larger more durable shank. (recommended for probing small un-passivated lines)

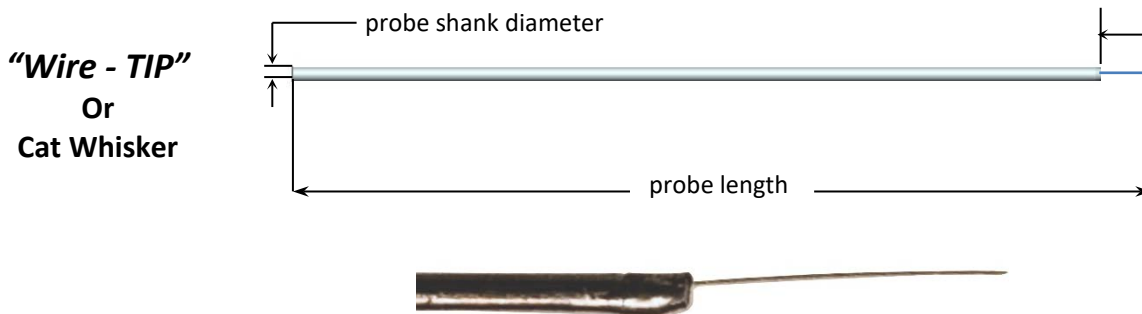

#### Wire Tip (Cat-Whisker) Probes

Model Number	Material	TIP Diameter	Shank Diameter	Length
SE-SM	Tungsten	1 $\mu\text{m}$	0.51mm	50.1mm
SE-SMS	Tungsten	0.2 $\mu\text{m}$	0.51mm	50.1mm
SM-10	Tungsten	0.2 $\mu\text{m}$	0.51mm	33mm
SM-35	Tungsten	0.7 $\mu\text{m}$	0.51mm	33mm

## ❖ WARRANTY

- Please Note that Probe Tips and Probe Tip Holders are considered a consumable item and may not be returned after use.
- Standard Warranty 12 months \*
- For Extended Warranty and Service Contracts: Contact Signatone Corp. for more information

\* See Signatone Corporate Terms and Conditions of Sale for further details.

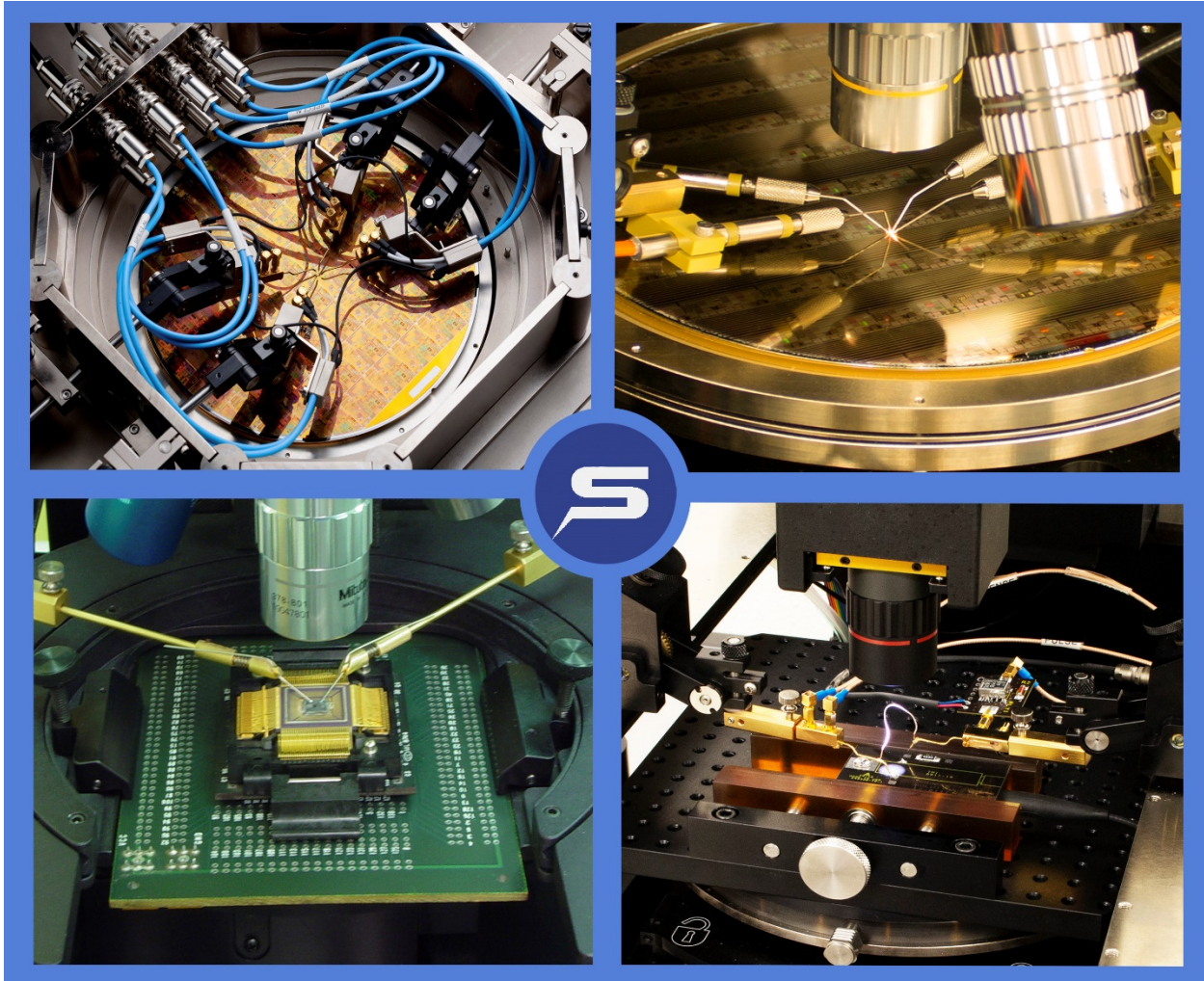

- **North America:** [Sales.NA@signatone.com](mailto:Sales.NA@signatone.com)
- **Europe:** [Sales.Europe@signatone.com](mailto:Sales.Europe@signatone.com)
- **Asia:** [Sales.Asia@signatone.com](mailto:Sales.Asia@signatone.com)