

SIGNATONE'S QuadPro2 Resistivity Measurement Systems

❖ FEATURES / BENEFITS

Designed for Various Levels of Automation and Semi-Production Applications

- Measures V/I, Sheet Resistance, Resistivity or Thickness
- Reports Average, Standard Deviation, Minimum, Maximum and 1Sigma for the data set
- Temperature Coefficient of Resistance (TCR) measurements integrated with automated temperature chuck and source meter. (Optional)
- Automated 2D Color Contour mapping, 3D and Cross section mapping
- Employs the Dual Configuration Testing method for improved accuracy and repeatability
- Tests samples 10mm to 300mm
- Comparative Mapping



❖ QuadPro2 Test & Calibration

NIST traceable calibration standards are available for purchase with the system. Proper use of the standards and the calibration procedure insures the specified system accuracy of better than 1%. Each time the probe head is changed, the system should be recalibrated using the standards. The calibration process is automated and only requires about 3 minutes. (See Calibration wafer options for more information)

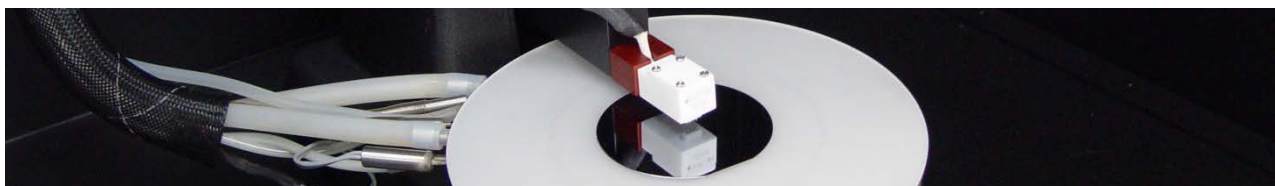

Shown above: SRS3-0.9 76.2mm NIST calibration wafer being used on a QaudPro2-MA8T with hot chuck.

❖ QuadPro2 Automatic System

The QuadPro2 automatic includes a computer, stepper controller, and base station with either a 200 or 300mm diameter isolated chuck. The software automatically defines the points for automated testing and mapping of the test sample. The user enters the sample size, sample shape, edge exclusion, and choice of 5, 9, 25, 49 or 121 test points. The software automatically defines the best probe position for creating a uniform contour map. Users may also define their own custom positioning map with up to 14,000 test points. The user map may be defined by moving to position and recording the location or entering X-Y positions into an X-Y position table.

With AutoRange mode enabled, at the first measurement, the QuadPro2 steps the current source through a number of settings, finding the best current setting for testing the sample under test. All subsequent test positions use the same current setting.

With Dual Configuration mode enabled, at each site, 4 different measurements are made applying the dual configuration (ASTM Standard F84-99) assuring that errors introduced by the probe head and edge proximity are eliminated. This greatly increases the repeatability and accuracy of measurements. The QuadPro2 automatically steps to each position and records the X-Y position, Sheet Resistance, Resistivity, Thickness and V/I measurement in a visible table.

Upon completion of the test points, a wafer contour map is displayed. The contour map may be toggled between 2D color, 3D full scale and 3D cross section viewing. Statistical data including the average, standard deviation, 1Sigma, maximum and minimum measurement results display prominently above the contour map. The results may then be printed or exported to a spread sheet for further analysis.



❖ **More Key features of the QuadPro2:**

- Automatic calculation of the test site locations based on size, number of test sites and edge exclusion.
- Automatic positioning of the test sample to each test site.
- Fast throughput with up to 50 measurements per minute.
- Measurement of Sheet Resistance, V/I, Resistivity or Thickness
- Auto-ranging the test meters to find the most accurate settings.
- Dual configuration to eliminate errors based on edge proximity or probe imperfections.
- Precise, repeatable mapping of the surface with selectable 5 to 1400 measurement points.

The screenshot displays the 'Comparison View' window of the QuadPro2 software. It is divided into two main sections for 'Test 1' and 'Test 2'. Each section includes a 3D contour map of a circular wafer, a 'Toggle Watermap/Contour' button, and a table of test parameters. A central data table lists 25 test points with their coordinates and resistance values. Navigation buttons like 'Prev Failed Pt', 'Next Failed Pt', and 'Back To Test' are visible at the bottom.

Pt	X1 (mm)	Y1 (mm)	R1 (Ohm/sq)	R2 (Ohm/sq)	X2 (mm)	Y2 (mm)
1	0	0	0.035932	0.038301	0	0
2	42.5	0	0.03598	0.036046	42.5	0
3	30.052	30.052	0.035447	0.035543	30.052	30.052
4	0	42.5	0.035163	0.035237	0	42.5
5	-30.052	30.052	0.034799	0.035133	-30.052	30.052
6	-42.5	0	0.03491	0.035434	-42.5	0
7	-30.052	-30.052	0.035847	0.03609	-30.052	-30.052
8	0	-42.5	0.03655	0.036791	0	-42.5
9	30.052	-30.052	0.036435	0.036397	30.052	-30.052
10	85	0	0.035144	0.034974	85	0
11	78.53	32.528	0.034598	0.034592	78.53	32.528
12	60.104	60.104	0.034335	0.034351	60.104	60.104
13	32.528	78.53	0.034282	0.034539	32.528	78.53
14	0	85	0.033922	0.034021	0	85
15	-32.528	78.53	0.033498	0.033798	-32.528	78.53
16	-60.104	60.104	0.032986	0.033322	-60.104	60.104
17	-78.53	32.528	0.03278	0.03324	-78.53	32.528
18	-85	0	0.033161	0.033955	-85	0
19	-78.53	-32.528	0.033772	0.034267	-78.53	-32.528
20	-60.104	-60.104	0.034815	0.035279	-60.104	-60.104
21	-32.528	-78.53	0.035855	0.036126	-32.528	-78.53
22	0	-85	0.036424	0.036398	0	-85
23	32.528	-78.53	0.036483	0.036177	32.528	-78.53
24	60.104	-60.104	0.036161	0.035858	60.104	-60.104
25	78.53	-32.528	0.035649	0.035037	78.53	-32.528

❖ **2D & 3D Contour Maps:**

After the automated testing, the contour maps are displayed. The 2D contour maps are displayed in black and white or colored regions. 3D graphs may be plotted in full scale or a cross section. Cross section maps may be defined on the X or Y axis. When the QuadPro2 is connected to a printer, the user selects the desired maps and summary to print.

The data table may be printed or exported as a delimited ascii file. Printing provides a choice of graphs and the data table.

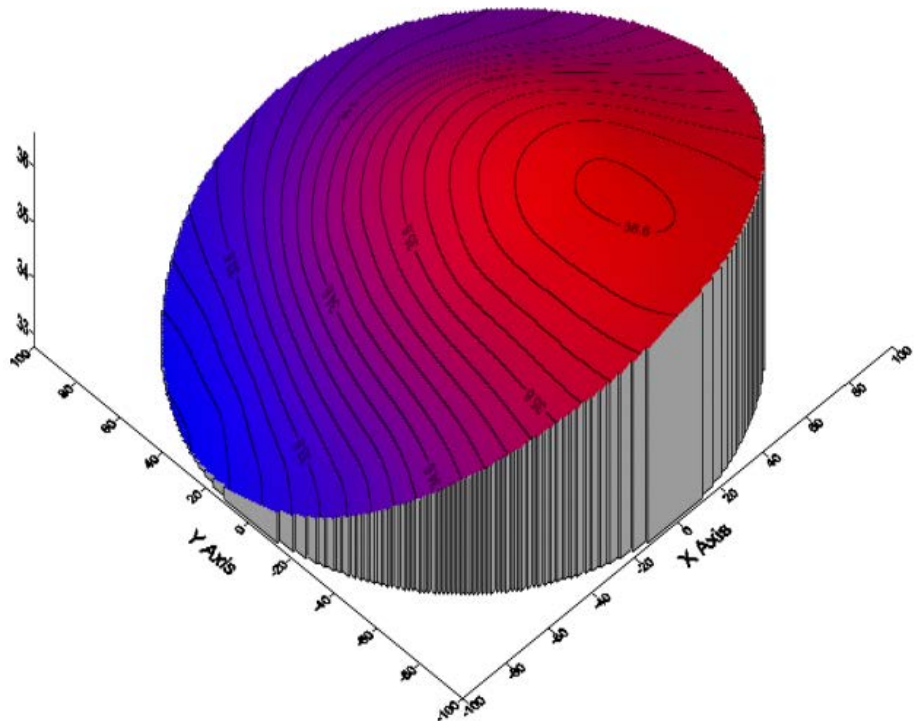

❖ Manual QuadPro2 System



A bench top manual positioning stand is also available for testing and mapping. A precision knob control allows X-Y positioning with millimeter accuracy. A digital monitoring system sends X & Y position with 0.1mm resolution to QuadPro2 software. The software displays the target position and the user moves the test sample to the position by turning the knobs and watching the display. A lever lowers the probe head into contact with the sample. The auto ranging, dual configuration, data collection, and mapping features function the same as the semi automatic system

❖ Four Point Probe Heads

Signatone offers two probe heads to choose from; the SP4 and the HT4. The SP4 is an inline probe made of delrin and used in most applications. Several choices are available for configuration to your specific application. The three spacings are .040, .050 and .0625 inches. The three pressures available are 45, 85, and 180 grams. Tips are made of Tungsten Carbide or Osmium and offer a choice of .0016, .005, .010 inches radius.

The HT4 inline four-point probe head is made of ceramic and designed for high temperature and high resistance measurements. The HT4 accurately collects data at temperatures up to 600°C.

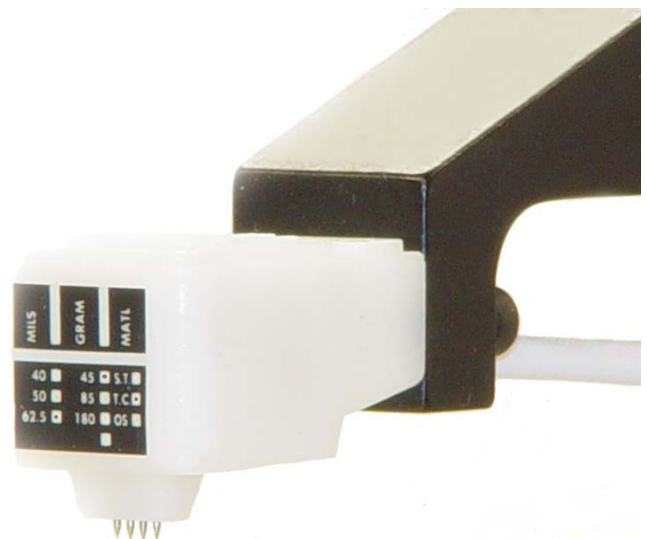

❖ *QuadPro2 TCR (Optional)*

The Temperature Coefficient of Resistance option integrates temperature control of the test sample as well as the automated source meter control and resistance calculations. Integrated with a Signatone thermal chuck system, the test automatically steps through the test temperatures without moving the probe tips. Measurements are taken at each of the target temperatures and results plotted on the graph. TCR is reported in Parts Per Million (PPM).

Users define the temperature range, temperature steps and dwell / settling time at each temperature before making a measurement. A variety of Signatone thermal chucks are available to define range and resolution with a range of ambient to 300°C, with 1° resolution.

For example, a typical test would be set at a range of 50°C to 250°C with 25° steps, dwell time of 5 minutes. The QuadPro2 automatically measures the resistance at 20°C (the reference temperature) then controls the thermal chuck to heat to 50°C. After dwelling 5 minutes at 50°C, a measurement is then taken, recorded and plotted on the graph. Next, the chuck is heated up to 75°C for the next step measurement. This process repeats until the last measurement at 250°C is complete. The chuck is then automatically cooled back to ambient. Then, if so defined, additional locations may be automatically tested on the same sample. Up to 9 points on a sample may be automatically tested and graphed. The data may be printed or exported to a spread sheet for further analysis.

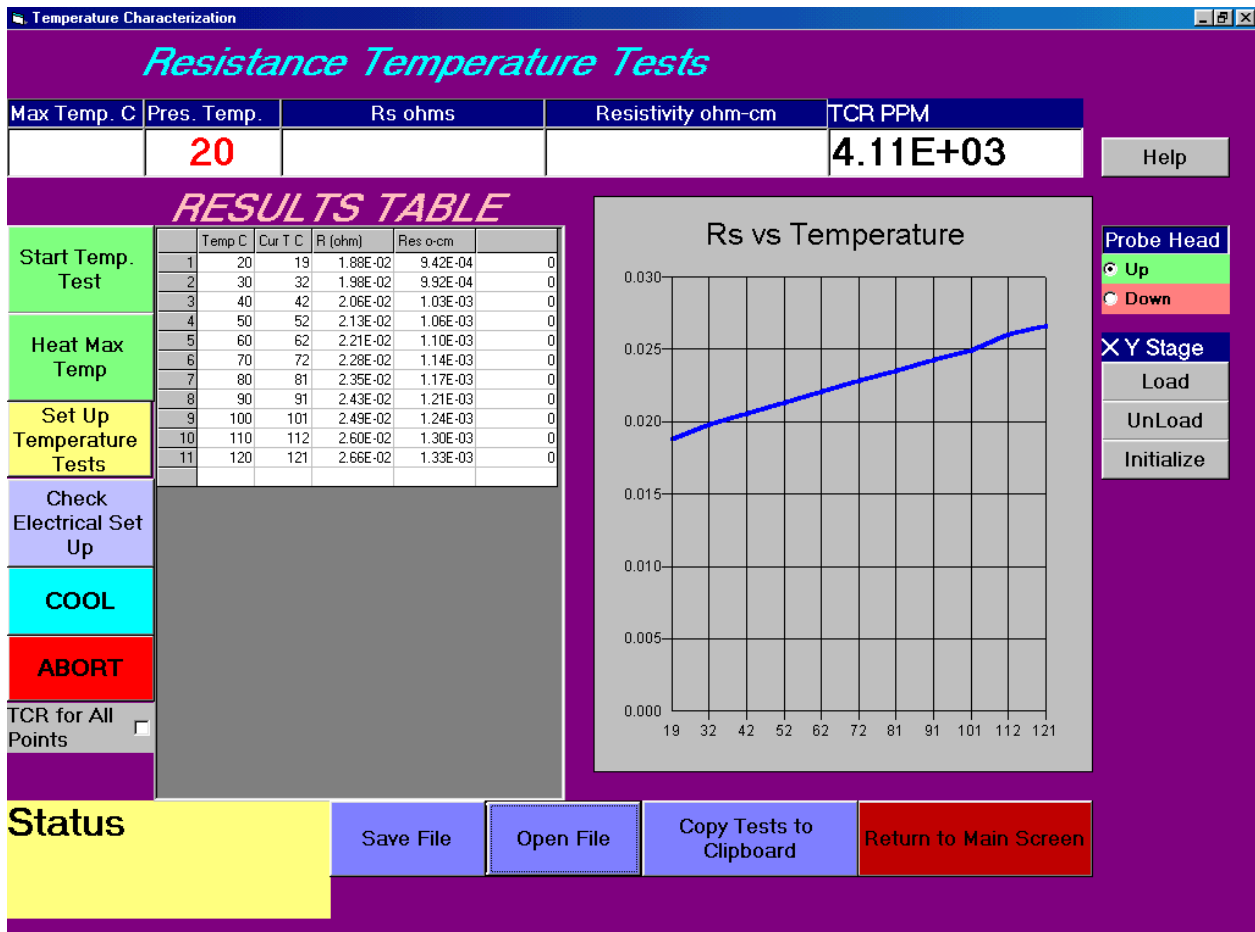



❖ QuadPro2 Order and Configuration Information

All QuadPro2 systems include the QuadPro2 software, two probe heads, necessary cabling to complete a working system and an operation manual. The QuadPro2 integrates Keithley Source meters for measurements. The different ranges available are directly based on the different Keithley model meters. Two SP4 probe heads with quick mounting blocks are provided with each system.

Model maker information

QuadPro2-[range][type][size][TCR option]

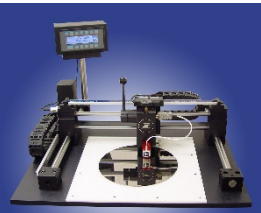
D	Standard range: 10μΩ to 100MΩ (with Keithley 2450)	
M	Recommended range: 1μΩ to 100MΩ	
G	High resistance range: 1mΩ to 10GΩ,	
A	Semiautomatic stand-alone configuration - latest Windows OS, moderate processor, RAM and HD, keyboard and mouse - automatic X-Y positioning stage - dark box enclosure - computer integrated into mobile rack with instrumentation - flat panel screen, keyboard and mouse - locking castors allowing stand-alone system to roll into place	
B	Bench top, manual motion configuration includes - computer integrated into rack with test meters - flat panel screen, keyboard and mouse - S-304 test stand with manual X-Y positioning- recommended for use with TRC option. - includes 200mm Ultem Chuck – Also for use with thermal chucks (TCR) - position digital readout	
U	Bench top, manual motion configuration includes - computer integrated into rack with test meters - flat panel screen, keyboard and mouse - S-305 stand with stationary DUT holder, for up to 300mm wafers - manual X-Y positioning of SP4 or HT4 four-point probe head - 300mm Delrin platform holds 100/150/200 & 300mm wafers - not available for use with TCR option	
R	Signatone S-M40 /S-M90 series Micropositioners with SP4/HT4 holder for use on existing Signatone probe station platforms. <i>(probe station not included with this item /ask us about Signatone probe station and QuadPro2 integration packages)</i>	
8	For samples 10mm - 200mm in diameter	
C	For samples 10mm - 300mm in diameter	
0	No TCR option	
T	Standard TCR option: range of 10°C to 300°C, 0.1°C resolution - requires S-1080 series controller and hot chuck <i>(quoted as separate line items)</i>	
U	Low range, precision TCR option: range of 10°C to 125°C, 0.1°C resolution - requires F25-HL fluid chuck controller and fluid chuck <i>(quoted as separate line items)</i>	

❖ **QuadPro2**

System Controller / Dimensions / Weight / Power Consumption

System Model	W x D x H (mm)	Weight (kg)	Weight (Lbs.)	Power cons. (VA)
QuadPro2-#-A##	572 x 978 x 1676	218	480	< 550
S-1080	432 x 512 x 178	24.5	54	< 2000
TC-II	355 x 711 x 610	50.8	112	< 1500
F25-HL	231 x 419 x 640	31.75	70	< 1500

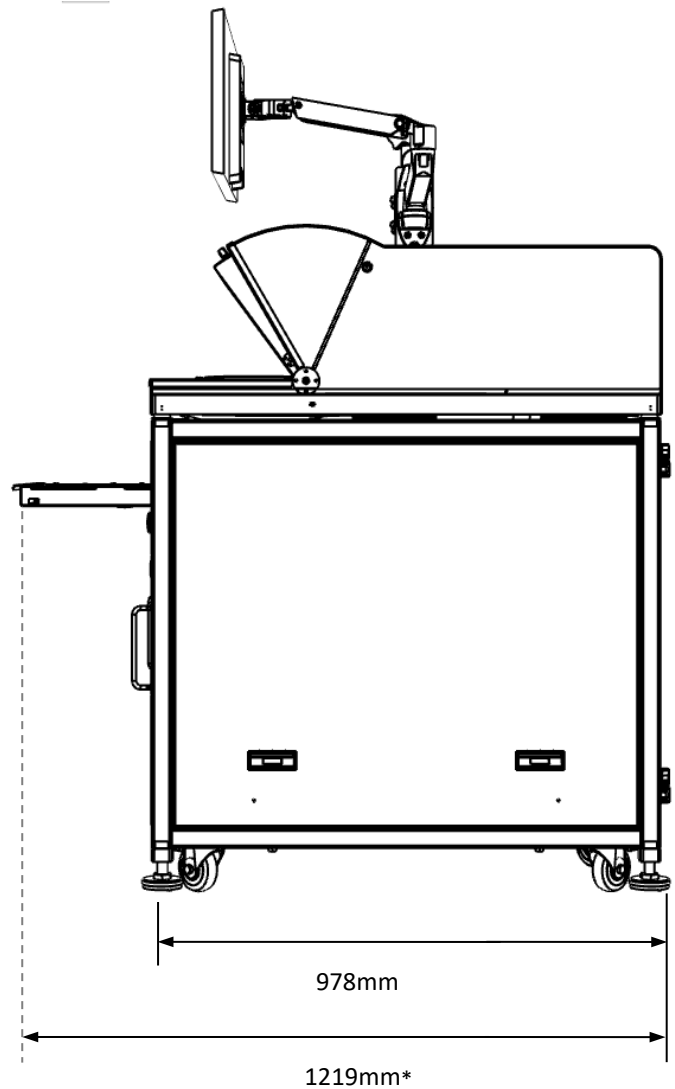
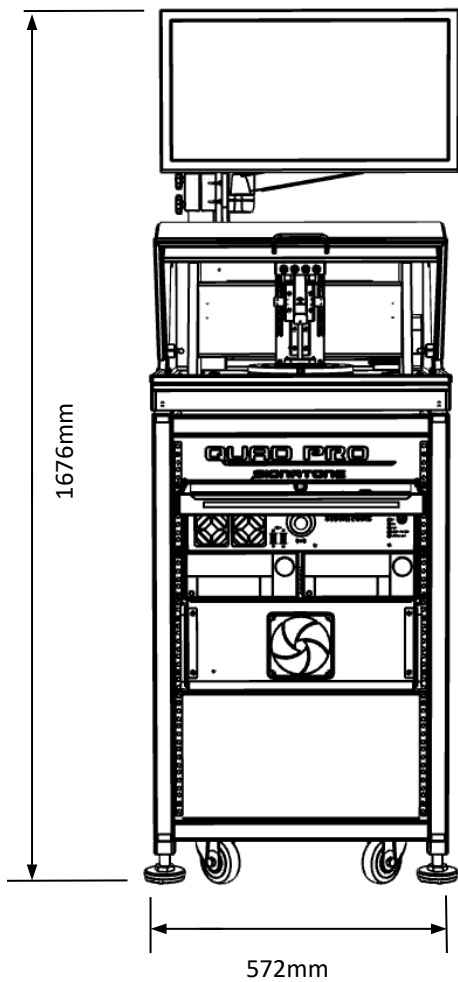

❖ FOUR POINT PROBE – MODEL MAKER

Standard Head (Delrin)

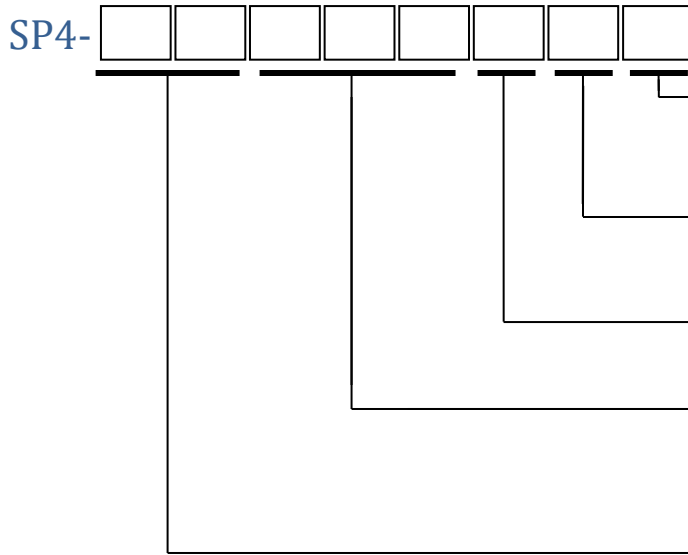

- S = Standard, flying lead termination
- Y = 15" wire, 9 pin D sub, for Pro4/S-302
- Q = 6" wire, 9 pin D sub, for QuadProII
- J = 36" wire with (4) Banana Plugs
- N = 36" Coaxial wire with 4 BNC

- R = 1.6 mil radius tip
- F = 5 mil radius tip
- B = 10 mil radius tip

- T = Tungsten Carbide
- O = Osmium

- 045 = 45 gram spring pressure
- 085 = 85 gram spring pressure
- 180 = 180 gram spring pressure

- 40 = 40 mil spacing between tips
- 50 = 50 mil spacing between tips
- 62 = 62.5 mil spacing between tips



SP4-62085TRY

Sample Part Numbers:

HT4-62180ORY

High Temperature or High Resistance Head (Macor)

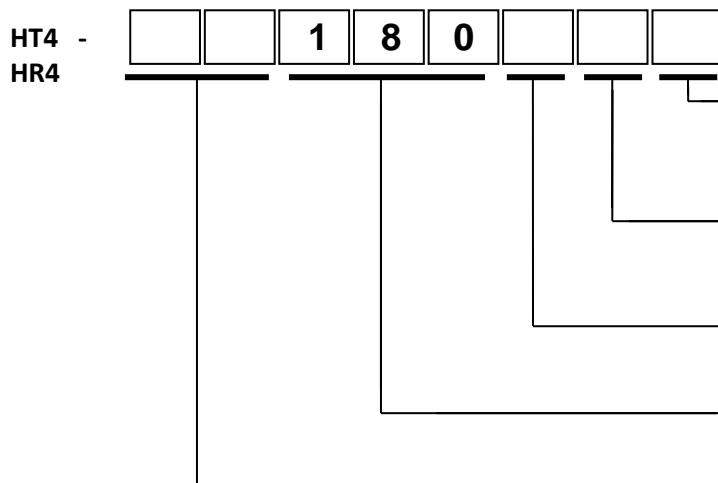

- S = Standard, flying lead termination
- Y = 15" wire, 9 pin D sub, for Pro4/S-302
- Q = 6" wire, 9 pin D sub, for QuadProII
- J = 36" wire with (4) Banana Plugs
- N = 36" Coaxial wire with 4 BNC connectors
- C = 36" Coaxial wire with 2 BNC connectors

- R = 1.6 mil radius tip
- F = 5 mil radius tip
- B = 10 mil radius tip

- T = Tungsten Carbide
- O = Osmium

- 180 = 180 gram spring pressure

- 50 = 50 mil spacing between tips
- 62 = 62.5 mil spacing between tips

❖ FOUR POINT PROBE – SELECTION GUIDE

How do I choose the best SP4 or HT4 for my application?

SELECTING THE BEST 4 POINT PROBE HEAD FOR YOUR APPLICATION

Choosing the right probe head is a matter of selecting the best spring pressure, probe tip radius, material and probe tip spacing for your application. The following is a guide for making the best selection; however, experience has shown best results are achieved by using guidelines to select the initial probe head, then experimenting with different spring pressures or materials to match the characteristics of your application.

Spring Pressure: The spring pressure is the pressure used to force each individual probe tip onto the sample surface to make electrical or ohmic contact. Lucas Signatone offers 45 gram, 85 gram and 180 gram spring pressures for standard probe heads (SP4 series) for testing below temperatures of 90 degrees C. Probe heads for use at higher temperatures (the HT4 series) have 180 gram spring pressures. The physical characteristics of the sample determine the correct spring pressure as follows:

- A. For easily contacted films such as metal films or soft films such as conductive polymers or very thin films, start with the lowest spring pressure that gives satisfactory contact, usually 45 grams.
- B. For difficult to contact samples such as high resistivity silicon or similar materials which naturally form a nonconductive layer when exposed to an air ambient, start with the high spring pressure of 180 grams. Note: Nonconductive layers may form when samples experience high temperatures; therefore, HT4 high temperature probes use 180 gram spring pressures.
- C. For intermediate or unknown films start with an 85 gram spring pressure probe.

Probe Tip Radius: Lucas Signatone probe tips are micro-machined to have the shape of a section of a sphere at the tip. 1.6 mil, 5 mil, and 10 mil tip radii are available. Generally the large tip radius probes are more robust, but it is more difficult to make good electrical contact with these probes. Use the following guide for the selection of tip radius:

- A. For easily contacted films and thin films start with a 5 mil tip radius.
- B. For very thin films start with a 10 mil probe tip radius.
- C. All other applications start with the standard 1.6 mil probe tip radius.

Probe Tip Material: Signatone offers 4-point probes with tips of either Tungsten Carbide or Osmium. Tungsten Carbide is a crystalline material that is very hard and can be broken along the crystal boundaries with horizontal motion of the probe. Osmium is an amorphous material and is also hard, but is more forgiving to small horizontal motion. It is believed that Osmium will give longer performance or more touch downs than Tungsten carbide, but it is slightly more expensive

❖ FOUR POINT PROBE – SELECTION GUIDE

Also, Osmium has the physical characteristic (work function) such that it can make better contact with some exotic materials. The following is suggested:

- A. For laboratory and low volume usage start with Tungsten Carbide.
- B. For production environment probing or contacting many points on the sample consider Osmium. Also, consider trying Osmium to improve contact.

Probe Spacing: The probes have a constant spacing, S , between each of the 4 tips. Lucas Signatone products use software with correction algorithms allowing for probing near the edge of the sample (to within a proximity of $4 \times S$) with 1% accuracy. Generally larger probe tip spacings give better results. Please use the following guide.

- A. For samples with geometry greater than 0.5 inch in diameter use 0.0625 inch (62.5 mils) spacing.
- B. For smaller samples or for probing closer than 0.25 inch to the edge use 0.040 (1mm or 40 mils) spacing.

<http://www.fourpointprobe.com/applications/resistivity.asp>

\$\$\$ SP4 / HT4 Pricing \$\$\$

For pricing, please configure the part number by using the above information, then send us an e-mail at: Sales@Signatone.com

➤ **How do I clean the tips of my SP4?**

Regarding the SP4 there is really no sure way to clean the tips. We certainly discourage the use of any chemicals, solvents or touching the tips with a cloth in attempt to wipe them clean. The only method that we have used is compressing the tips 20-50 times on a ceramic surface but there is no specification for the outcome of this process or guarantee that this will clean the tips, as in most cases this does not work. If there is visible debris on the tips you can try using high pressure air to blow away the debris. The SP4 is disposable and priced to be easily replaced and most models are on the shelf for immediate shipment ARO.

❖ **FOUR POINT PROBE – SELECTION GUIDE**

The SP4 probe head is designed for use with Signatone and other resistivity probing systems for the measurement of thin films and materials.

The SP4 head has several configurations parameters permitting users to define the probe head best for their application.

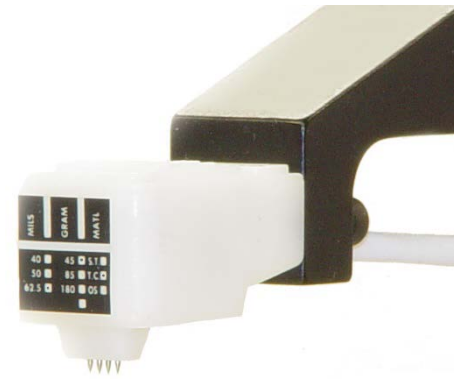

➤ **Spacing Between Tips**

- 0.0625 inches (62)
- 0.050 inches (50)
- 0.040 inches (40)

➤ **Pressure On Each Tip**

- 45 grams (045)
- 85 grams (085)
- 180 grams (180)

➤ **Probe Tip Material**

- Osmium (O)
- Tungsten Carbide (T)

➤ **Tip Radius**

- 0.0016 inches [1.6mil] (R)
- 0.005 inches [5 mil] (F)
- 0.010 inches [10 mil] (B)

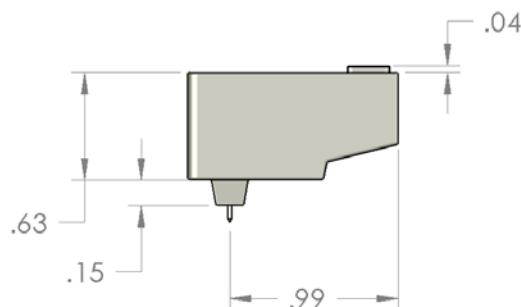
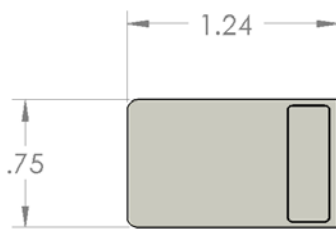

❖ **Electrical Connection Options**

- Flying lead termination, 15" wire (S)
- 9 pin D sub with 15" wire (Y)
- 9 pin D sub with 6" wire (Q)
- 4 36" wires with Banana Plugs (J) *
- 4 36" coax wires with BNC (N)*
- 2 36" coax wires with BNC (C)*
- 4 36" Triax wire with TRX (HT4) (X)*
- 2 8" Triax wire with TRX (HT4) (D)*

* for direct connection to various meters

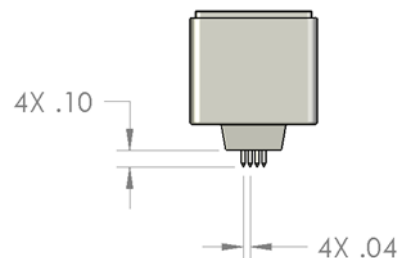
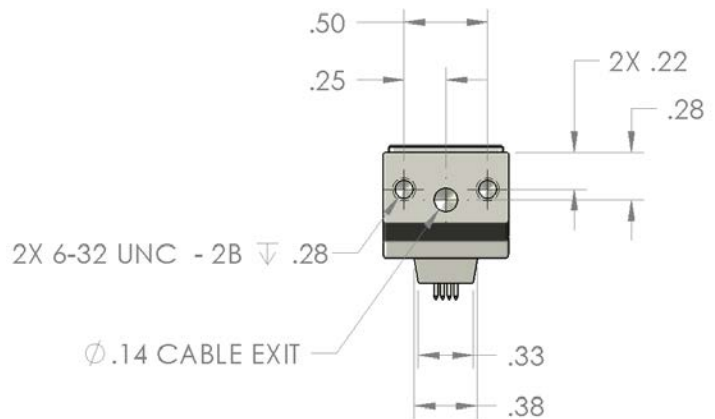

❖ FOUR POINT PROBE – MOUNTING OPTIONS

L-4PQM Quick Mounting Block

Use the L-4PQM to mount the SP4 and HT4 probe heads to any late model Lucas / Signatone Corp. resistivity test stand.

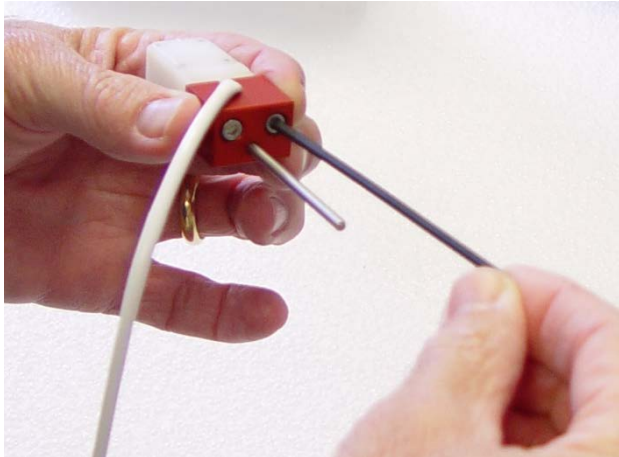

Back View
Mounting Holes

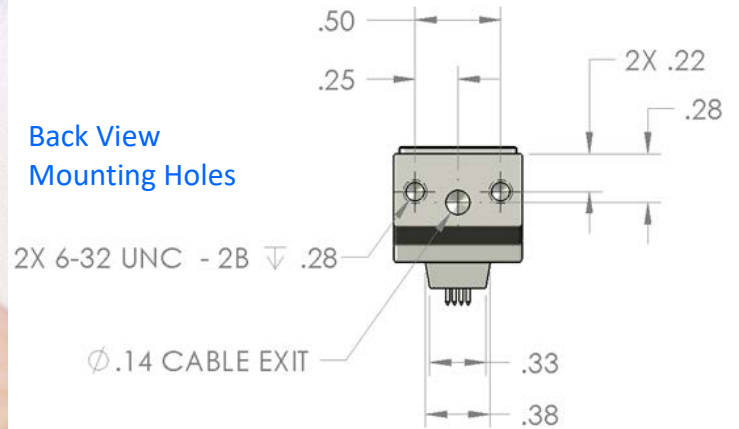

Use these dimensions to create your own mounting device.

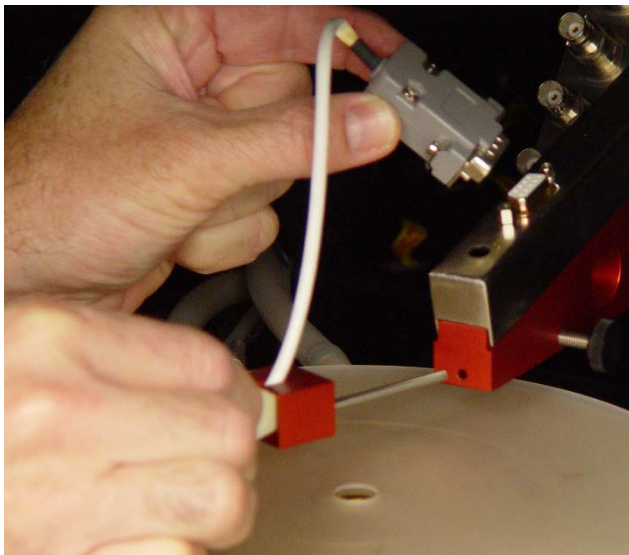
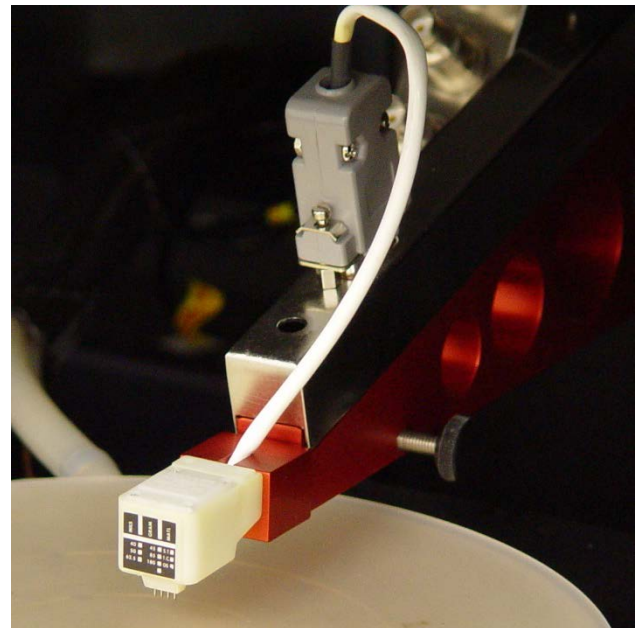
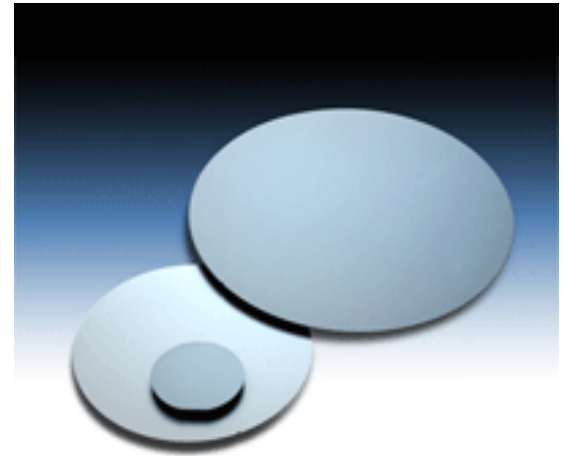

Photo: L-4PQM quick mounting block, holding SP4-62085TRQ mounted to our QuadProII S-A8 resistivity test station



❖ **VLSI CALIBRATION STANDARDS (NIST TRACEABLE)**

- Resistivity Standards (RS) span 4 decades and are designed for resistance calibration of contact resistivity measuring instruments. The resistance calibration standard is created by sawing a doped single crystalline ingot into wafers, lapping and chemically cleaning them to VLSI Standards' specifications.
- The resistance calibration standards are bare silicon wafers available in 76.2mm, 200mm, and 300mm sizes. The silicon is p-type (Boron) doped to nominal resistivity values, from 0.002 ohm.cm to 3 ohm.cm as available on the 3" model. For enhanced resistance calibration and measurement standard on contact probes, the wafers are lapped and chemically polished. The increased surface roughness allows cleaner penetration through the native oxide layer and better contact.
- Each wafer is certified at its center and traceable for accuracy. Certificates of Calibration are provided with each resistance calibration standard and report the resistivity, sheet resistance and thickness calibration and measurement values with calculated uncertainties.



The Resistivity Standard, available in three wafer sizes, 76.2mm, 200mm & 300mm (upon request)

Wafer Size	Resistivity [Ohm.cm]	Sheet resistance [Ohms/Sq.]	Thickness	Signatone Part Number
76.2 mm	0.002	0.04	508 μm	SRS3-0.002
76.2 mm	0.008	0.16	508 μm	SRS3-0.008
76.2 mm	0.01	0.2	508 μm	SRS3-0.01
76.2 mm	0.03	0.6	508 μm	SRS3-0.03
76.2 mm	0.1	2	508 μm	SRS3-0.1
76.2 mm	0.3	6	508 μm	SRS3-0.3
76.2 mm	0.9	18	508 μm	SRS3-0.9
76.2 mm	3	59	508 μm	SRS3-3
76.2 mm	30	591	508 μm	SRS3-30
300 mm upon request				
200 mm	0.01	0.14	710 μm	SRS8-0.01
200 mm	0.03	0.42	710 μm	SRS8-0.03
200 mm	0.1	1.4	710 μm	SRS8-0.1
200 mm	0.3	4.2	710 μm	SRS8-0.3
200 mm	1	14	710 μm	SRS8-1
200 mm	3	42	710 μm	SRS8-3
200 mm	10	141	710 μm	SRS8-10
200 mm	30	423	710 μm	SRS8-30
300 mm upon request				

IMPORTANT!

Calibration methods using Signatone’s RS test software included with our Pro4, QuadPro2 and ΩPro test systems are highly repeatable when used with these high-quality materials. When a VLSI, NIST traceable standard is used, the measurements may be set to correlate with the standard. Calibration should be done weekly or after changing probe heads. When performing calibration measurements with a 4-point-probe instrument, you must ensure that the probes and the silicon make solid, repeatable contact. Poor contact is revealed by a high standard deviation of multiple measurements taken from the same area or in some cases, zero-voltage readings.

Note: Typical delivery lead times for these wafers is 6-10 weeks and varies per product.

❖ Four Point Probe Theory

Resistivity, **Rho**, is a particularly important semiconductor parameter because it can be related directly to the impurity content of a sample; the four-point probe is the apparatus typically used to determine bulk Resistivity.

The mobility of the carriers depends upon temperature, crystal defect density, and ALL impurities present. Hall Effect Measurements can determine the mobility of the carriers in a given sample to allow for more accurate dopant concentration measurements, but Hall measurements are usually destructive to the sample.

The four-point probe contains four thin collinearly placed tungsten wire probes which are made to contact the sample under test. Current **I** is made to flow between the outer probes, and voltage **V** is measured between the two inner probes, ideally without drawing any current. If the sample is of semi-infinite volume and if the inter-probe spacing is **s1 = s2 = s3 = s**, then it can be shown that the Resistivity of the semi-infinite volume is given by:

$$\mathbf{Rho} = (\mathbf{\pi s}) \mathbf{V/I} \quad (1)$$

The subscription in the preceding equation indicates the measured value of the Resistivity and is equal to the actual value, **Rho**, only if the sample is of semi-infinite volume. Practical samples, of course, are of finite size. Hence, in general, **Rho ! = Rho**. Correction factors for six different boundary configurations have been derived by Valdes (1). These show that in general, if **l**, the distance from any probe to the nearest boundary, is at least 5s, no correction is required. For the cases when the sample thickness is 5s, we can compute the true Resistivity from:

$$\mathbf{Rho} = \mathbf{a 2 \pi s V/I} = \mathbf{Rho} \quad (2)$$

Where **a** is the thickness correction factor which is plotted (on page 3). From an examination of the plot we see that for values of **t/s >= 5** times the probe spacing, no correction factor is needed. Typical probe spacings are 25-60 mils and the wafers used in most cases are only 10-20 mils, so unfortunately, we cannot ignore the correction factor. Looking again at the plot, however, we see that the curve is a straight line for values of **t/s <= 0.5**. Since it is a log-log plot the equation for the line must be of the form:

$$\mathbf{a=K (t/s)^m} \quad (3)$$

where **K** is the value of **a** at **(t/s) = 1**, and **m** is the slope. Inspection of the plot shows that in this case **m = 1**. **K** is determined to be 0.72 by extrapolating the linear region up to the value at **(t/s) = 1**. (The exact value can be shown to be **1/(2 ln 2)**.) Hence for slices equal to or less than one half the probe spacing **a = 0.72 t/s**.

When substituted into the basic equation we get:

$$\mathbf{Rho} = \mathbf{a 2 \pi s V/I} = \mathbf{4.53 t V/I, (t/s) <= 0.5} \quad (4)$$

All samples we will be using in the lab satisfy the one-half relationship so we can use the above formula to determine **Rho**. We will perform Resistivity measurements on the starting material for each experiment. The value of **r** obtained will be referred to as the bulk Resistivity, and the units are Ohm-cm.

the end-to-end resistance of a rectangular sample. From the familiar resistance formula:

❖ Four Point Probe Theory continued:

$$R_s = \text{Rho}/t = 4.53 \text{ V}/I \text{ for } t/s \leq 0.5 \text{ (5)}$$

which we refer to as sheet resistance. When the thickness t is very small, as would be the case for a diffused layer, this is the preferred measurement quantity. Note that R_s is independent of any geometrical dimension and is therefore a function of the material alone. The significance of the sheet resistance can be more easily seen if we refer to the end-to-end resistance of a rectangular sample. From the familiar resistance formula:

$$R = \text{Rho } l/wt \text{ (6)}$$

we see that if $w = l$ (a square) we get:

$$R = \text{Rho}/t = R_s$$

Therefore, R_s may be interpreted as the resistance of a square sample, and for this reason the units of R_s are taken to be ohms-per-square or ohm/sq. Dimensionally this is the same as ohms but this notation serves as a convenient reminder of the geometrical significance of sheet resistance.

So far in our discussion of Resistivity measurements we have assumed that the size of our sample is large compared to the probe spacing so that edge effects could be ignored. This is usually the case for the bulk Resistivity measurement. However, our sheet resistance measurements will be made on a "test area" on our wafer and the test area dimensions (nominally 2.9 by 5.8mm) are not that large compared to the probe spacing (25 mils). In order to get accurate measurements, we will need to correct for the edge effects. In general, then:

$$R_s = C \text{ V}/I \text{ (7)}$$

where C is the correction factor. Note that for $d/s > 40$, $C = 4.53$, the value we had as the multiplier in Equation (5).

References: Valdes, L.G., Proc. I.R.E., 42,pp. 420-427 (February 1954) Smits, F. M., "Measurements of Sheet Resistivity with the Four Point Probe," BSTJ, 37, p. 371 (1958).

Same as BT Monograph, 3894, Part 2
Courtesy of: ECE344: Theory and Fabrication of Integrated Circuits
Electrical and Computer Engineering
University of Illinois – Urbana/Champaign

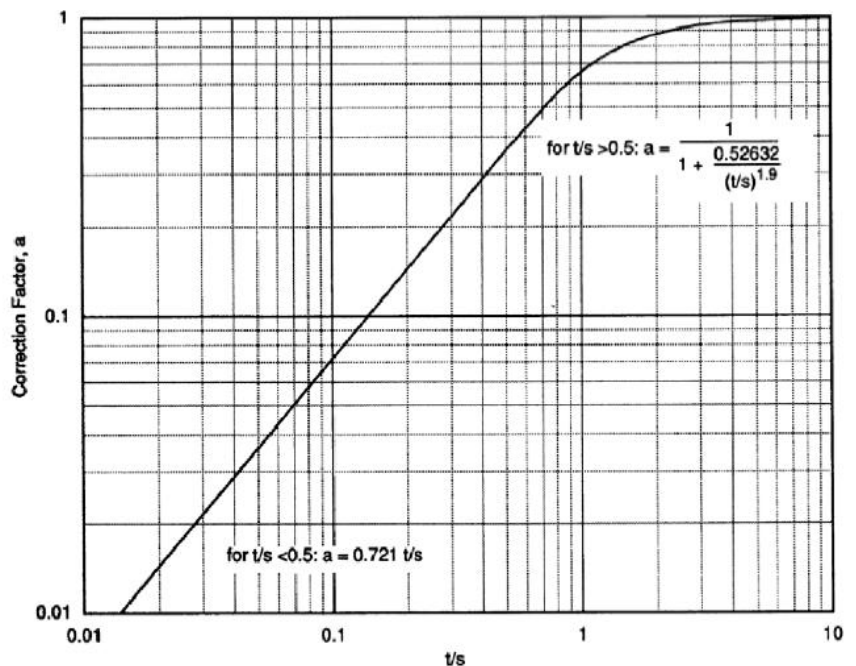

❖ **WARRANTY**

- Standard Warranty 12 months *
 - For Extended Warranty and Service Contracts : Contact Signatone Corp. for more information
- * See Signatone Corporate Terms and Conditions of Sale for further details.

Ask us about our family of Resistivity Test Equipment

Key features included in all Signatone systems include *Autorange* and *dual configuration*. *Autorange* automatically finds the ideal current setting to meet the parameters of the standard for measuring. At the first test site, the software controls the current source to step through a number of settings until the measured voltage is in target range as defined by the standard. This current is then used for all subsequent measurements of the sample. *Dual configuration* mode applies the standard ## to automatically correct for geometric errors caused by probe spacing and/or edge proximity improving overall accuracy.

Signatone offers Family of Products- The QuadPro2 for R&D and the Pro4 for basic, manual measurements, Ω Pro - Resistance Testing System. Each family has a variety of options and configurations. With over 60 configurations to choose from, Signatone has the product that will meet your application.



Ω Pro - Resistance Testing System



Pro 4 Series
For Manual Measurements

- North America: Sales.NA@signatone.com
- Europe: Sales.Europe@signatone.com
- Asia: Sales.Asia@signatone.com

